

Earth-Rite® II MGV

Mobile Grounding Verification System

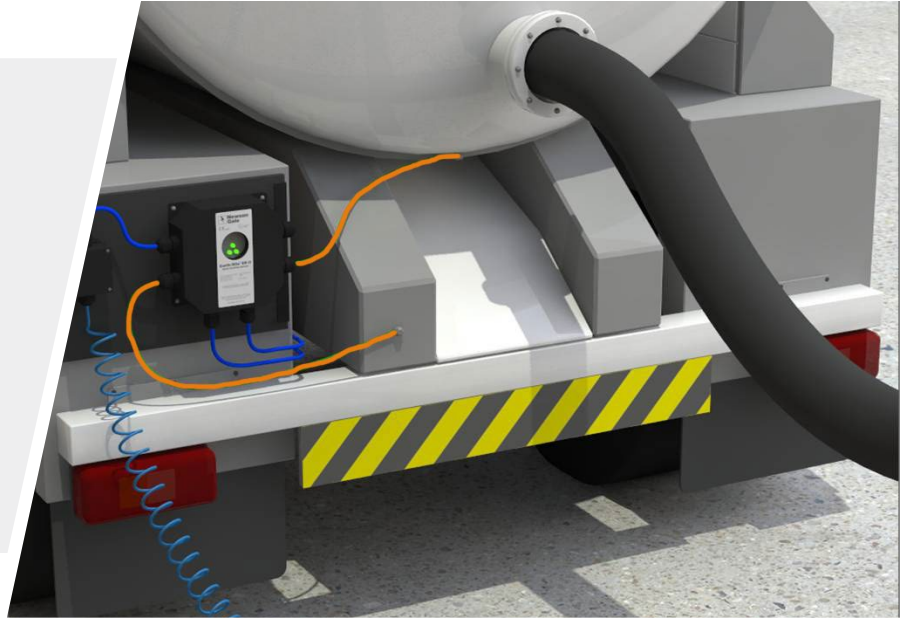

Earth-Rite II MGV Mobile Grounding Verification System



The Earth-Rite® II Mobile Ground Verification system (MGV) is a unique, patented technology designed to provide automatic confirmation of a positive electrostatic ground connection for trucks collecting and transferring flammable / combustible products.

Vacuum trucks and tank trucks, including their hoses and hose connections, are susceptible to static charge accumulation during the transfer of product into or out of the truck's containment system. This accumulation of static charge is equivalent to a hidden source of ignition and if discharged as a static spark can lead to the ignition of the product or the atmosphere in which the truck and material handling team is operating.

To mitigate the risk of incendive static spark discharges the **API RP 2219: Safe Operation of Vacuum Trucks in Petroleum Service** recommends that vacuum truck operators transferring flammable and combustible product in hazardous locations must fully ground the truck prior to any other task in the transfer operation by connecting the truck to a "proven ground source".

The Earth-Rite II MGV is designed to enable operators to establish safe grounding of their vehicle in accordance with this standard.

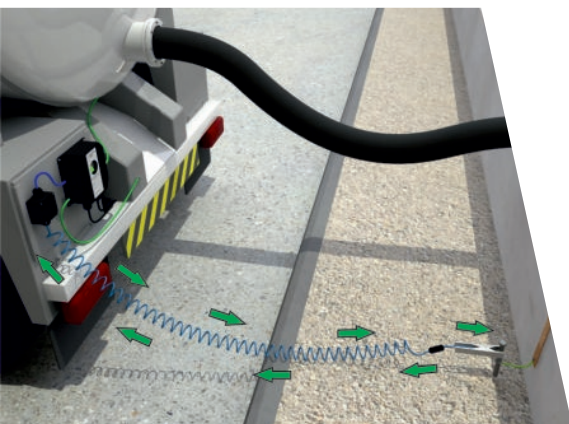

Continuous Ground Loop Monitoring check

Typical Grounding Applications:

- Cleaning & material recovery operations for on-site cleaning of storage tanks and chemical spills
- Transporting chemicals to various stages of production on chemical manufacturing sites
- Transporting flammable product to and from external sites where installed grounding systems are not present or have not been verified by the supplier
- Hazmat Recovery operations recovering flammable spillages following transportation and loss of containment incidents

Earth-Rite® II MGV

The **Earth-Rite II MGV** system performs two system checks which ensures the vehicle can dissipate static charges for the duration of the transfer process.

1. Static Ground Verification

The MGV system ensures the connection resistance of the object that is identified as the ground source to earth, is low enough to safely dissipate static charges from the truck.

2. Continuous Ground Loop Monitoring

When the Static Ground Verification process is confirmed, the Earth-Rite II MGV system continuously monitors the connection resistance of the truck to this verified grounding point for the duration of the transfer process. This connection resistance must be maintained at 10 Ohms (or less) for the duration of the transfer process.

Two output contacts located in the control unit of the Earth-Rite II MGV system can interlock with pumps or other control devices to prevent transfer operations should a static ground connection fail to be established or maintained for the transfer process.

Easy and Quick Operation

Removing the need for taking manual resistance readings or interacting with complex system interfaces the operator activates the system by simply connecting the system's grounding clamp to a site designated grounding point, buried metal structure (pipes, storage tanks) or temporary points like buried grounding rods.

When the **Static Ground Verification and Continuous Ground Loop Monitoring** checks are positive, a cluster of attention grabbing green LEDs pulse continuously informing the operator that the truck is securely grounded.



Quick release static grounding clamp supplied with the Earth-Rite II MGV attached to buried rod

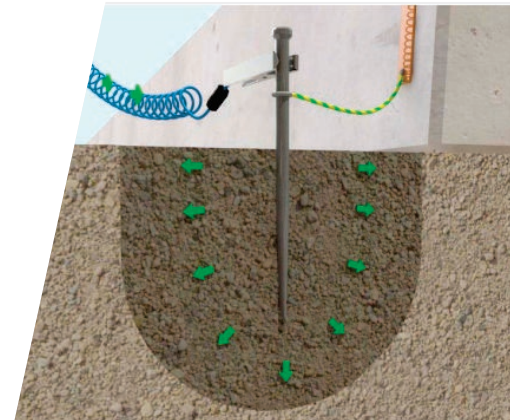

Static Ground Verification check



The Earth-Rite II MGV static grounding system can be mounted on vacuum trucks and tank trucks.

System Installation

- The Earth-Rite II system is powered by the vehicle's primary 24 V or 12 V battery supply with the control unit mounted on the truck chassis.
- Once the process is complete and any interconnecting pipework has been removed, to avoid damage/injury, the clamp should be carefully removed and placed on the appropriate stowage point.

Options

Ex(d)/XP enclosure for trucks parked in Class I, Div.1 / Zone 1

Intrinsically Safe (I.S) Switching PCB

Certification



Ingress Protection
IP 66

Temperature Range
-40°F to +131°F - cCSAus
-40°C to +55°C - ATEX/IECEX

Power Supply
12 V or 24 V DC

Earth-Rite® II MGV

Technical Specification

GRP (Class I, II, III - Div. 2 installations)

Power Supply & Monitoring Unit

Power Supply	12 V or 24 V DC
Power Rating	10 watt
Ambient Temperature Range	-13°F to +131°F
Ingress Protection	Type 4X (IP 66)
Weight	4.4 lb (2 kgs) nett
Construction	Static Dissipative Glass Reinforced Polyester
Monitoring Circuit	Intrinsically safe (ia)
Monitoring Loop Resistance	Nominally ≤ 10 Ohm ($\pm 10\%$)
Output Relay Contact Rating	2 off dry contacts, 250 V AC 5 A 500 VA max resistive 30 V DC 2 A 60 W max resistive
Cable Entries	7 x M20 (4 plugged)

Junction Box/Stowage Point

Enclosure Material	GRP with carbon loading
Terminals	2 x AWG #14 (2.5mm ²) conductor capacity
Stowage Device	Insulated universal stowage pin
Cable Entries	1 x M20
Clamp Cable Connection	Quick Connect

Grounding Clamp

Clamp Design	2 pole with tungsten carbide teeth
Body	Stainless steel (SS grade: 304)
ATEX / FM / IECEx Certification:	Ex II 1 GD T6 (Assessed to EN 13463-1 : 2009) ATEX certificate number: Sira 02ATEX9381 FM Certificate of Compliance number: 3046346 IECEx Ex h IIC T6 Ga Ex h IIIC T85°C Da Ta = -40°C to +60°C IECEx EXV 20.0033

Spiral Cable

Cable	Blue Cen-Stat Hytrel sheath (Static dissipative, chemical & abrasion resistant)
Conductors	2 x AWG #18 copper
Length	50 ft (15 m) extended (optional cable reel and additional lengths of Hytrel cable available - please inquire)

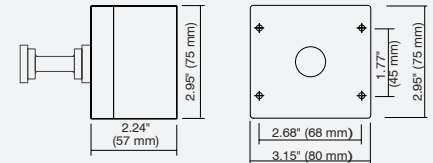
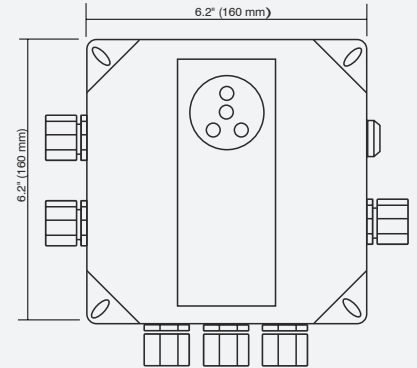

Simple Apparatus
GRP junction box with nylon grounding clamp stowage pin

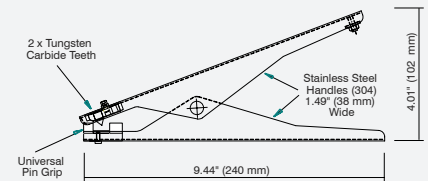

Static Grounding Clamp
Dual core stainless steel grounding clamp fitted with one pair of tungsten carbide tips

Earth-Rite® II MGV

Hazardous Area Certification

North America:

Europe / International Version Available:

NEC 500 / CEC (Class & Division)

Associated Equipment [Ex ia] for use in
 Class I, Div. 2, Groups A, B, C, D
 Class II, Div. 2, Groups E, F, G
 Class III, Div. 2,
 Providing Intrinsically Safe circuits for
 Class I, Div. 1, Groups A, B, C, D
 Class II, Div. 1, Groups E, F, G
 Class III, Div. 1
 When installed per Control Dwg;
 ER11-Q-10165 cCSAus
 Ta = -25°C to +55°C (-13°F to +131°F)

OSHA recognised NRTL: CSA.

NEC 505 & 506 (Class & Zoning)

Class I, Zone 2, (Zone 0), AEx nA[ia] IIC T4
 (gas & vapour)
 Class II, Zone 21, AEx tD[iaD] 21, T70°C
 (combustible dusts)

CEC Section 18 (Class & Zoning)

Class I, Zone 2 (Zone 0) Ex nA[ia] IIC T4
 DIP A21, IP66, T70°C

IECEX

Ex ec nC [ia] IIC T4 Gc(Ga)
 (gas & vapour)
 Ex tb IIIC T70°C Db
 (combustible dusts)
 Ta = -40°C to +55°C
 IECEX EXV 19.0059X
 IECEX Certifying Body: ExVeritas

ATEX

⊕ II 3(1) G
 Ex II 2D
 Ex ec nC [ia] IIC T4 Gc(Ga)
 Ex tb IIIC T70°C Db
 Ta = -40°C to +55°C
 ExVeritas 19ATEX0545X
 ATEX Notified Body: ExVeritas

Additional Certification

Safety Integrity Level:

SIL 2 (in accordance with IEC/EN 61508)

EMC Tested:

to EN 61000-6-3, EN 61000-6-2
 FCC - Part 15 (Class B)

Earth-Rite® II MGV

Technical Specification and Certification Data

XP (Class I, II, III - Div. 1 Installation)

Monitoring Unit

Power Supply	12 V or 24 V DC
Power Rating	10 watt
Ambient Temperature Range	-40°F to +122°F (-40°C to +50°C)
Ingress Protection	Type 4X (IP 66)
Weight	9.9 lbs (4.5 kgs) nett
Construction	Copper-free cast aluminium
Monitoring Circuit	Intrinsically safe (ia)
Monitoring Loop Resistance	Nominally ≤ 10 Ohm ($\pm 10\%$)
Output Relay Contact Rating	2 off dry contacts, 250 V AC 5 A 500 VA max resistive 30 V DC 2 A 60 W max resistive
Cable Entries	7 x 3/4" NPT (Supplied with 4 stopper plugs)

Junction Box/Stowage Point

Enclosure Material	GRP with carbon loading
Terminals	2 x AWG #14 conductor capacity
Stowage Device	Insulated universal stowage pin
Cable Entries	1 x M20
Clamp Cable Connection	Quick Connect

Grounding Clamp

Clamp Design	2 pole with tungsten carbide teeth
Body	Stainless Steel (SS grade: 304)
ATEX / FM / IECEx Certification:	Ex II 1 GD T6 (Assessed to EN 13463-1 : 2009) ATEX certificate number: Sira 02ATEX9381 FM Certificate of Compliance number: 3046346 IECEx Ex h IIC T6 Ga Ex h IIIC T85°C Da Ta = -40°C to +60°C IECEx EXV 20.0033

Spiral Cable

Cable	Blue Cen-Stat Hytrel sheath (Static dissipative, chemical & abrasion resistant)
Conductors	2 x AWG #18 copper
Length	50 ft (15 m) extended (optional cable reel and additional lengths of Hytrel cable available - please inquire)

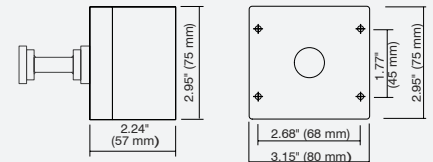
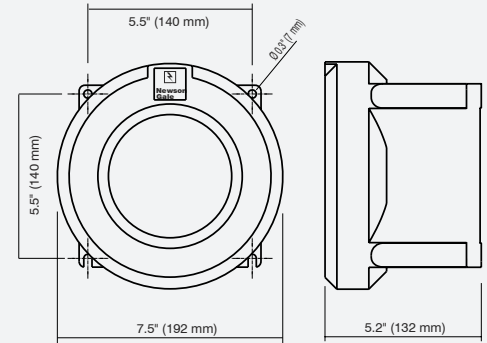

Simple Apparatus
GRP Junction box with nylon grounding clamp stowage pin

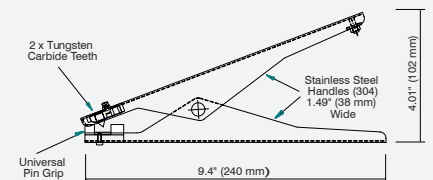

Static Grounding Clamp
Dual core stainless steel grounding clamp fitted with one pair of tungsten carbide tips

Earth-Rite® II MGV

Hazardous Area Certification

North America:

Europe / International Version Available:

NEC 500 / CEC (Class & Division)

Associated Equipment [Ex ia] for use in
 Class I, Div. 1, Groups A, B, C, D
 Class II, Div. 1, Groups E, F, G
 Class III, Div. 1
 Providing intrinsically safe circuits for
 Class I, Div. 1, Groups A, B, C, D
 Class II, Div. 1, Groups E, F, G
 Class III, Div. 1
 When installed per Control Dwg;
 ER11-Q-10110 cCSAus
 Ta = -40°C to +50°C (-40°F to +122°F)

OSHA recognised NRTL: CSA

NEC 505 & 506 (Class & Zoning)

Class I, Zone 1 [0] AEx d[ia] IIC T6 Gb(Ga)
 (gas & vapour)
 Class II, Zone 21 [20] AEx tD [iaD] 21
 T80oC (combustible dusts)

CEC Section 18 (Class & Zoning)

Class I, Zone 1[0] Ex d[ia] IIC T6 Gb(Ga)
 DIP A21, IP66, T80°C

IECEX

Ex d[ia] IIC T6 Gb(Ga)
 (gas & vapour)
 Ex tb IIIC T80°C IP66 Db
 (combustible dusts)
 Ta = -40°C to +55°C
 IECEX EXV 19.0052
 IECEX Certifying Body: ExVeritas

ATEX

II 2(1)GD
 Ex d[ia] IIC T6 Gb(Ga)
 Ex tb IIIC T80°C IP66 Db
 Ta = -40°C to +55°C
 ExVeritas 19ATEX0537
 ATEX Notified Body: ExVeritas

Additional Certification

Safety Integrity Level:

SIL 2 (in accordance with IEC/EN 61508)

EMC Tested:

to EN 61000-6-3, EN 61000-6-2
 FCC - Part 15 (Class B)

System Options

Portable Static Grounding Kit

A quick and easy to use grounding kit which may be swiftly deployed in emergency or combustible material transfer operations where pre-existing designated grounding points are not available or accessible.

The portable grounding kit combines multiple shortened grounding rods (14" long) with surface wire grounding techniques to provide acceptably low resistance for static grounding requirements in field operations.

The flexible array of interconnected grounding rods is inserted into the soil at specified intervals to maximize the ability to safely dissipate static electricity from mobile trucks, service vehicles and other equipment.

- Kit includes multiple rods, surface grounding wires, ground tab and driver tool
- Quick and easy to install and retrieve
- Static Grounding Canvas Kit Bag for Portable Grounding Kit and Cen-Stat™ Clamps, Assemblies and Tools



Retractable Cable Reel

The retractable cable reel is supplied for grounding system installations where customers want to ensure the grounding clamp and cable are returned to the static grounding system by operators and drivers on completion of the product transfer process. The **Reel** can be used in conjunction with the **Earth-Rite II MGV**.

- Certified for Div. 1 and 2 hazardous locations
- Self-retracting with up to 50 ft. (15 m) of Hytrel® protected cable
- Silver plated ultra low resistance slip ring contacts
- ATEX - II 2 GD T6



Intrinsically Safe (I.S) Switching PCB

The I.S Switching PCB is an additional circuit board added to Newson Gale system enclosures that enable users to directly interface with, and switch intrinsically safe circuits without the need for additional equipment. The I.S Switching PCB is designed not to affect the I.S signals electrical parameters and is compatible with the **Earth-Rite II MGV**.

- 30 V DC, 500 mA
- Li = 0H, Ci = 0F
- Suitable for Ex ia, ib, ic rated intrinsically safe circuits only
- NAMUR Compatible



System Options

Earth-Rite II MGV Tester

This Tester provides competent electrical personnel with the ability to confirm that the functional characteristics of the Earth-Rite II MGV static grounding system are working to parameters that will confirm a truck is safely grounded when deployed in the field. The easy to use tester enables the user to “dial in” a number of settings via a pair of rotary switches that indicate the Earth-Rite II MGV system is fit for use. The Tester should be used during the installation of Earth-Rite II MGV systems and during scheduled maintenance for trucks on which Earth-Rite II MGV systems are installed.

Functional Parameter Tests:

- **Static Ground Verification**
Ensures the Earth-Rite II MGV only goes permissive on a value of resistance to True Earth that is capable of dissipating static charges safely
- **Continuous Loop Monitoring**
Ensures the Earth-Rite II MGV system only goes permissive when the connection resistance between the truck and ground source is 10 Ohms or less
- **Clamp and Cable test**
Ensures good continuity in the circuit through the grounding clamp teeth, conductors and Quick Connect



Copyright Notice

The website and its content is copyright of Newson Gale Ltd © 2020. All rights reserved.

Any redistribution or reproduction of part or all of the contents in any form is prohibited other than the following:

- you may print or download to a local hard disk extracts for your personal and noncommercial use only
- you may copy the content to individual third parties for their personal use, but only if you acknowledge the website as the source of the material

You may not, except with our express written permission, distribute or commercially exploit the content. Nor may you transmit it or store it in any other website or other form of electronic retrieval system.

Right to change

This document provides general information only and may be subject to change at any time without notice. All information, representations, links or other messages may be changed by Newson Gale at any time without prior notice or explanation.

Newson Gale is not obliged to remove any outdated information from its content or to expressly mark it as being outdated. Please seek the advice of professionals as necessary regarding the evaluation of any content.

Disclaimer of liability

The information provided in this Datasheet is provided by Newson Gale without any representations or warranties, expressed or implied, as to its accuracy or completeness. The liability of Newson Gale for any expenses, losses or actions incurred whatsoever by the recipient as a result of the use of this Datasheet shall be excluded.

Leading the way in hazardous area static control



www.newson-gale.com

8/8

United Kingdom
Newson Gale Ltd
Omega House
Private Road 8
Colwick, Nottingham
NG4 2JX, UK
+44 (0)115 940 7500
groundit@newson-gale.co.uk

United States
IEP Technologies LLC
417-1 South Street
Marlborough, MA 01752
USA
+1 732 961 7610
groundit@newson-gale.com

Deutschland
IEP Technologies GmbH
Kaiserswerther Str. 85C
40878 Ratingen
Germany
+49 (0)2102 58890
erdung@newson-gale.de