

# Earth-Rite® II FIBC

Static Earthing Protection for Type C FIBCs



Online Enquiry >



Earth-Rite II FIBC Type C Static Earthing System

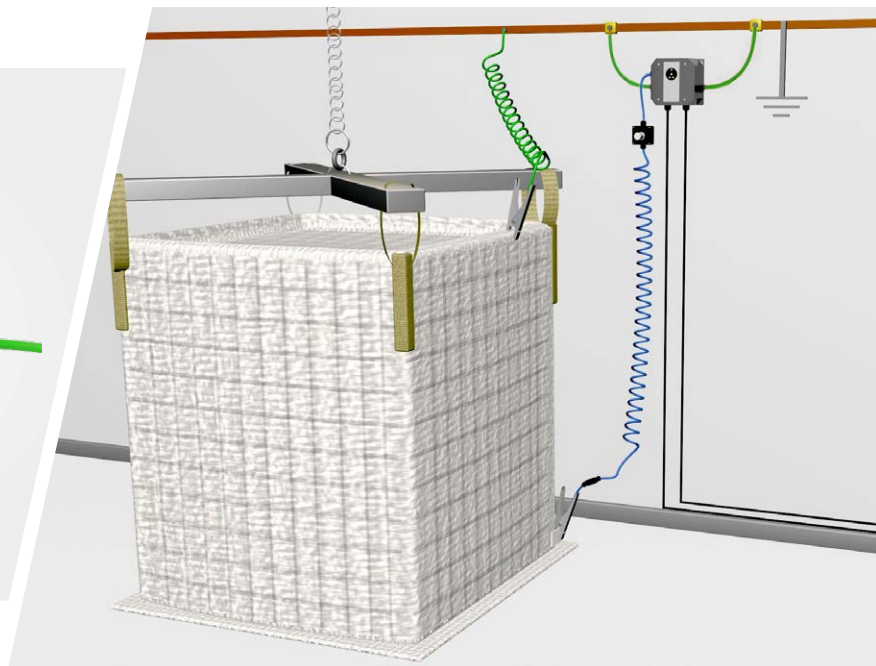

Typical Earth-Rite II FIBC installation consisting of two grounding clamps that establish a continuous ground monitoring loop with the site's locally verified true earth ground source.

IEC TS 60079-32-1 addresses the potential for static charge accumulation on FIBC and lists the four types of FIBC specified in IEC 61340-4-4.

With respect to Type C FIBC, it states: "Type C FIBC are designed to be connected to earth during filling and emptying operations."

The Earth-Rite® II FIBC is a grounding system for Type C bags that are manufactured in accordance with IEC 61340-4-4. It consists of a grounding system and a pair of grounding clamps.

If the resistance through the conductive or static dissipative elements of the Type C bag is less than the required threshold, the ground status indicators switch from red to pulsing green.

It should be noted that the grounding system is not a substitute for the test methods outlined in IEC 61340-4-4. The grounding system indicates that the threshold resistance of the conductive dissipative / components of the bag are in line with the specified resistance range and that a ground loop has been established with the site's locally verified ground source.

The static dissipative performance of the bag is the sole responsibility of the bag manufacturer and the site owner.

**\* Recommended upper monitoring resistance level:-**

- IEC 61340-4-4 Electrostatics – Part 4-4: Standard test methods for specific applications – Electrostatic classification of flexible intermediate bulk containers (FIBC), states that the resistance through a Type C FIBC bag should not exceed  $1 \times 10^8$  Ohms (100 Meg Ohm).
- NFPA 77 Recommended Practice on Static Electricity, states that the resistance through a Type C FIBC bag should not exceed  $1 \times 10^7$  Ohms (10 Meg Ohm).



## The Earth-Rite II FIBC includes:

- Static Dissipative GRP Enclosure with Intrinsically Safe Monitoring Circuits.
- FIBC Grounding Clamp with single conductor Hytrel® Protected Cable.
- Junction Box with Stowage Pin for stowing FIBC Grounding Clamp.

The Earth-Rite II FIBC can be installed in Zoned / Classified combustible dust atmospheres. If gas and vapour atmospheres are present an Ex(d) / XP, Zone 1 / Class I, Div. 1 system may be specified.

## Earth-Rite® II FIBC

### Features

#### Continuous Ground Loop Monitoring

The grounding system clamp, which must be connected to the identified earthing tab on the bag, provides an intrinsically safe signal that returns to the grounding system via a locally verified ground source.

This circuit establishes a ground monitoring resistance loop so that when the resistance threshold is below (100 Meg Ohm) or (10 Meg Ohm) the grounding system will go permissive. When the permissive condition is met the ground status indicators switch from red to pulsing green. The most consistent method of achieving a ground return path is with a second grounding clamp supplied with the system. This must be connected to a separate identified grounding tab connection point, preferably to the opposite end of the bag to which the system grounding clamp is connected.

The locally verified and maintained/tested ground source must be verified by the site owner/responsible as being connected to the general mass of the earth suitable to dissipate static charges. (Contact Newson Gale for further details).

#### Volt Free Contacts

Earth-Rite system output contacts can be interlocked with process equipment and/or strobes. Interlocking the grounding system with the process equipment can enhance the Standard Operating Procedures (SOP) before the movement of material can take place. Interlocking with strobes provides personnel with a wider field of view that the grounding SOP is underway.

On rare occasions grounding clamps can be removed by operators or lose contact with equipment due to unstable connections being made initially or overstretching of the cable connected to the grounding clamp. The grounding system can, via the output contacts, halt the process. However, please be aware that the movement of the product may not stop even though the equipment has halted. This could lead to the continued generation of static charge. In such circumstances it is the responsibility of the site operator to ensure their SOPs cater for such scenarios. This assumes the grounding system has been installed in accordance with the Instruction Manual. If you do not have access to an Instruction Manual contact Newson Gale.

#### Loading Operation:

Varying cable lengths are available to attach the clamp to the FIBC bag. However, if the bag loading / unloading process is aggressive and could cause the grounding clamp connection to be compromised irrespective of cable length, an alternative means of grounding the bag will need to be sourced.



Earth-Rite II FIBC stainless steel grounding clamp with Quick Connect and optional lengths of Hytrel protected single core cable included

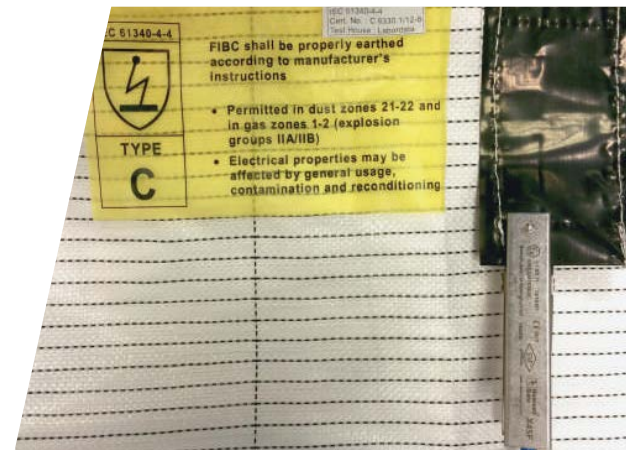

## Earth-Rite® II FIBC

### Technical Specification

GRP (Zone 2 Gas / Vapour Atmospheres - Zone 21 & 22 Dust Atmospheres)

#### Power Supply & Monitoring-Unit

|   |  |
|---|--|
| <b>Power Supply</b>                             | 115 V or 230 V AC, 50-60 Hz<br>12 V or 24 V DC   |
| <b>Power Rating</b>                             | 10 watt  |
| <b>Ambient Temperature Range</b>                | -40°C to +55°C   |
| <b>Ingress Protection</b>                       | IP 66  |
| <b>Weight</b>                                   | 1.5 kg (3.3 lbs) nett  |
| <b>Construction</b>                             | Carbon-Loaded GRP  |
| <b>Monitoring Circuit</b>                       | Intrinsically safe   |
| <b>Operational Monitoring Resistance of Bag</b> | Nominally $\leq 1 \times 10^8$ or $1 \times 10^7 \Omega$ ( $\pm 10\%$ )  |
| <b>Output Relay Contact Rating</b>              | 2 volt free change over switch contacts,<br>250 V AC, 5 A, 500 VA max resistive,<br>30 V DC, 2 A, 60 W max resistive |

**Cable Entries** 7 x M20 (2 x plugged)

#### Junction Box/Stowage Point

|                               |  |
|-------------------------------|--|
| <b>Enclosure Material</b>     | GRP with carbon loading                    |
| <b>Terminals</b>              | 2 x 2.5 mm <sup>2</sup> conductor capacity |
| <b>Stowage Device</b>         | Insulated universal stowage pin            |
| <b>Cable Entries</b>          | 1 x 20 mm                                  |
| <b>Clamp Cable Connection</b> | Quick Connect                              |

#### Grounding Clamp

|                     |  |
|---------------------|--|
| <b>Clamp Design</b> | 1 pole with single stainless steel contact |
| <b>Body</b>         | Stainless Steel (SS grade: 304)            |

#### ATEX / FM / IECEx / UKEX Certification:

**ATEX**  
II 1 GD T6  
(Assessed to EN 13463-1 : 2009)  
Sira 02ATEX9381  
ATEX Notified Body: SIRA  
**FM** Certificate of Compliance number: 3046346

#### UKCA Ex

II 1 G  
II 1 D  
Ex h IIC T6 Ga  
Ex h IIIC T85°C Da  
Ta = -40°C to +60°C  
ExVeritas 21UKEX0842  
UKCA Ex Approved Body: ExVeritas

**IECEx**  
Ex h IIC T6 Ga  
Ex h IIIC T85°C Da  
Ta = -40°C to +60°C  
IECEx EXV 20.0033  
IECEx Certified Body: ExVeritas

#### Spiral Cable

|                   |   |
|-------------------|---|
| <b>Cable</b>      | Blue Cen-Stat Hytrel sheath (Static dissipative, chemical & abrasion resistant)   |
| <b>Conductors</b> | 1 x 4.00 mm <sup>2</sup> steel  |
| <b>Length</b>     | 3 m (10 ft), 5 m (16 ft), 10 m (32 ft) or 15 m (50 ft) 2 pole Cen-Stat blue spiral cable with Hytrel coating which has colour, UV protective and static dissipative additives |

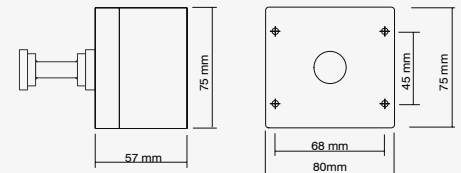
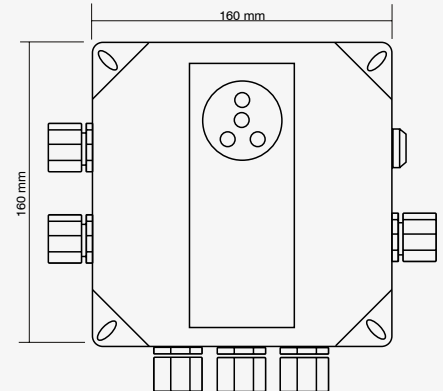

Simple Apparatus  
GRP junction box with nylon grounding clamp stowage pin

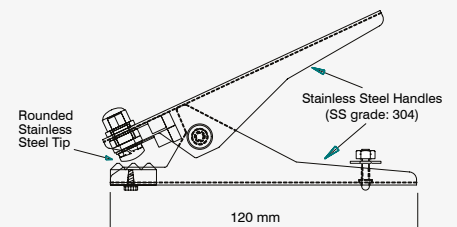

FIBC Monitoring Clamp

## Earth-Rite® II FIBC

### Hazardous Area Certification

**Europe / International:**

**IECEX**

Ex ec nC [ia Ga] IIC T4 Gc  
Ex tb [ia Da] IIIC T70°C Db  
Ta = -40°C to +55°C  
IECEX EXV 19.0059X  
IECEX Certifying Body: ExVeritas

**ATEX**

 II 3(1)G  
II 2(1)D  
Ex ec nC [ia Ga] IIC T4 Gc  
Ex tb [ia Da] IIIC T70°C Db  
Ta = -40°C to +55°C  
ExVeritas 19ATEX0545X  
ATEX Notified Body: ExVeritas

**UKCA Ex**

 II 3(1)G  
II 2(1)D  
Ex ec nC [ia Ga] IIC T4 Gc  
Ex tb [ia Da] IIIC T70°C Db  
Ta = -40°C to +55°C  
ExVeritas 21UKEX0833X  
UKCA Ex Approved Body: ExVeritas

**CCC**

Ex nA nC [ia Ga] IIC T4 Gc  
Ex tD A21 IP66 T70°C  
2021312304001041  
Approved Body: CNEX

**KCS (Gas)**

Ex ec nC [ia Ga] IIC T4 Gc(Ga)  
Ta = -40°C to +55°C  
22-AV4BO-0319X  
Approved Body: KOSHA

**KCS (Dust)**

Ex tb IIIC T170°C Db  
Ta = -40°C to +55°C  
22-AV4BO-0320X  
Approved Body: KOSHA

**North America Version Available:**

**NEC 500 / CEC (Class & Division)**

Associated Equipment [Ex ia] for use in  
Class I, Div. 2, Groups A, B, C, D  
Class II, Div. 2, Groups E, F, G  
Class III, Div. 2  
Providing Intrinsically Safe circuits for  
Class I, Div. 1, Groups A, B, C, D  
Class II, Div. 1, Groups E, F, G  
Class III, Div. 1  
Ta = -13°F to +131°F  
OSHA recognised NRTL: CSA

**NEC 505 & 506 (Class & Zoning)**

Class I, Zone 2, (Zone 0), AEx nA[ia] IIC T4  
Class II, Zone 21, AEx tD[iaD] 21, T70°C

**CEC Section 18 (Class & Zoning)**

Class I, Zone 2 (Zone 0) Ex nA[ia] IIC T4  
DIP A21, IP66, T70°C

### Additional Certification

**Safety Integrity Level:**

SIL 2 (in accordance with IEC/EN 61508)

**EMC Tested:**

to EN 61000-6-3, EN 61000-6-2  
FCC - Part 15 (Class B)

## Earth-Rite® II FIBC

### Technical Specification

Exd (Zone 1 Gas / Vapour Atmospheres - Zone 21 Dust Atmospheres)

#### Power Supply & Monitoring Unit

|   |  |
|---|--|
| <b>Power Supply</b>                             | 115 V or 230 V AC, 50-60 Hz<br>12 V or 24 V DC   |
| <b>Power Rating</b>                             | 10 watt  |
| <b>Ambient Temperature Range</b>                | -40°C to +55°C   |
| <b>Ingress Protection</b>                       | IP 66  |
| <b>Weight</b>                                   | 4.5 kgs (9.9 lbs) nett   |
| <b>Construction</b>                             | Copper-free cast aluminium   |
| <b>Monitoring Circuit</b>                       | Intrinsically safe   |
| <b>Operational Monitoring Resistance of Bag</b> | Nominally $\leq 1 \times 10^8$ or $1 \times 10^7 \Omega$ ( $\pm 10\%$ )  |
| <b>Output Relay Contact Rating</b>              | 2 off voltage free change-over switch contacts,<br>250 V AC, 5 A, 500 VA max resistive<br>30 V DC, 2 A, 60 W max resistive |
| <b>Cable Entries</b>                            | 7 x M20 (2 x plugged)  |

#### Junction Box/Stowage Point

|                               |  |
|-------------------------------|--|
| <b>Enclosure Material</b>     | GRP with carbon loading                    |
| <b>Terminals</b>              | 2 x 2.5 mm <sup>2</sup> conductor capacity |
| <b>Stowage Device</b>         | Insulated universal stowage pin            |
| <b>Cable Entries</b>          | 1 x 20 mm                                  |
| <b>Clamp Cable Connection</b> | Quick Connect                              |

#### Grounding Clamp

|                     |  |
|---------------------|--|
| <b>Clamp Design</b> | 1 pole with single stainless steel contact |
| <b>Body</b>         | Stainless Steel (SS grade: 304)            |

#### ATEX / FM / IECEx / UKEX Certification:

#### UKCA Ex

Ex h IIC T6 Ga  
Ex h IIIC T85°C Da  
Ta = -40°C to +60°C  
ExVeritas 21UKEX0842  
UKCA Ex Approved Body: ExVeritas

#### ATEX

II 1 GD T6  
(Assessed to EN 13463-1 : 2009)  
Sira 02ATEX9381  
ATEX Notified Body: SIRA  
FM Certificate of Compliance number: 3046346

#### IECEx

Ex h IIC T6 Ga  
Ex h IIIC T85°C Da  
Ta = -40°C to +60°C  
IECEx EXV 20.0033  
IECEx Certified Body: ExVeritas

#### Spiral Cable

|                   |   |
|-------------------|---|
| <b>Cable</b>      | Blue Cen-Stat Hytrel sheath (Static dissipative, chemical & abrasion resistant)   |
| <b>Conductors</b> | 1 x 4.00 mm <sup>2</sup> steel  |
| <b>Length</b>     | 3 m (10 ft), 5 m (16 ft), 10 m (32 ft) or 15 m (50 ft) 2 pole Cen-Stat blue spiral cable with Hytrel coating which has colour, UV protective and static dissipative additives |

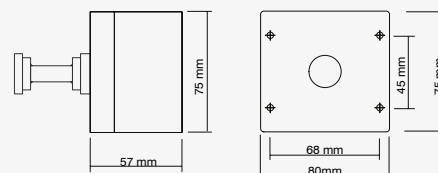
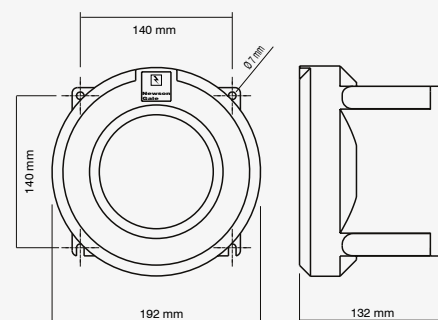

Simple Apparatus  
GRP junction box with nylon grounding clamp stowage pin

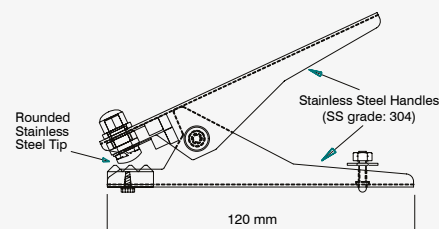

FIBC Monitoring Clamp

## Earth-Rite® II FIBC



### Hazardous Area Certification

#### Europe / International:



##### **IECEX**

Ex db [ia Ga] IIC T6 Gb  
Ex tb [ia Da] IIIC T80°C Db  
Ta = -40°C to +55°C  
IECEX EXV 19.0052  
IECEX Certifying Body: ExVeritas

##### **ATEX**

 II 2(1)G  
 II 2(1)D  
Ex db [ia Ga] IIC T6 Gb  
Ex tb [ia Da] IIIC T80°C Db  
Ta = -40°C to +55°C  
ExVeritas 19ATEX0537  
ATEX Notified Body: ExVeritas

##### **UKCA Ex**

 II 2(1)G  
 II 2(1)D  
Ex db [ia Ga] IIC T6 Gb  
Ex tb [ia Da] IIIC T80°C Db  
Ta = -40°C to +55°C  
ExVeritas 21UKEX0832X  
UKCA Ex Approved Body: ExVeritas

##### **CCC**

Ex d [ia Ga] IIC T6 Gb  
Ex tD A21 IP66 T80°C  
2021312304001040  
Approved Body: CNEX

##### **KCS (Gas)**

Ex d [ia Ga] IIC T6 Gb(Ga)  
Ta = -40°C to +55°C  
22-AV4BO-0334X  
Approved Body: KOSHA

##### **KCS (Dust)**

Ex tb IIIC T80°C Db  
Ta = -40°C to +55°C  
22-AV4BO-0335X  
Approved Body: KOSHA

#### North America Version Available:

##### **NEC 500 / CEC (Class & Division)**

Associated Equipment [Ex ia] for use in  
Class I, Div. 1, Groups A, B, C, D  
Class II, Div. 1, Groups E, F, G  
Class III, Div. 1  
Providing intrinsically safe circuits for  
Class I, Div. 1, Groups A, B, C, D  
Class II, Div. 1, Groups E, F, G  
Class III, Div. 1  
Ta = -40°F to +122°F  
OSHA recognised NRTL: CSA.

##### **NEC 505 & 506 (Class & Zoning)**

Class I, Zone 1 [0] AEx d[ia] IIC T6 Gb(Ga)  
Class II, Zone 21 [20] AEx tD [iaD] 21 T80°C

##### **CEC Section 18 (Class & Zoning)**

Class I, Zone 1[0] Ex d[ia] IIC T6 Gb(Ga)  
DIP A21, IP66, T80°C

### Additional Certification

#### **Safety Integrity Level:**

SIL 2 (in accordance with IEC/EN 61508)

#### **EMC Tested:**

to EN 61000-6-3, EN 61000-6-2  
FCC - Part 15 (Class B)

## System Options

### Installer's Kit

The kits provide installation engineers with the necessary Ex (d) enclosure glands required to complete an **Earth-Rite® II FIBC** installation as specified in the system installation manual.

#### Kit A

Ex (d) IP68 glands (x2) for armoured cable 9 mm to 13.5 mm Ø\*,  
Ex (d) IP68 glands (x3) for non-armoured cable 4 mm to 8.4 mm Ø\*,  
IP68 plastic gland for junction box cable, 3m of 2 core conductor cable (x1) to connect system enclosure to clamp stowage box, 1m of solid green earth loop cable (x2) with PCB connectors and 10 mm bolt eyelets attached.

#### Kit B

Ex (d) IP68 glands (x5) for non-armoured cable 4 mm to 8.4 mm Ø\*,  
IP68 plastic gland for junction box cable, 3m of 2 core conductor cable (x1) to connect system enclosure to clamp stowage box, 1m of solid green earth loop cable (x2) with PCB connectors and 10 mm bolt eyelets attached.

#### Kit C (GRP/P1)

Ex (e) IP68 glands (x5) for non-armoured cable 6 mm to 13 mm Ø,  
IP68 plastic gland for junction box cable, 3m of 2 core conductor cable (x1) to connect system enclosure to clamp stowage box, 1m of solid green earth loop cable (x2) with PCB connectors and 10 mm bolt eyelets attached.

\* For areas not requiring IIC apparatus.

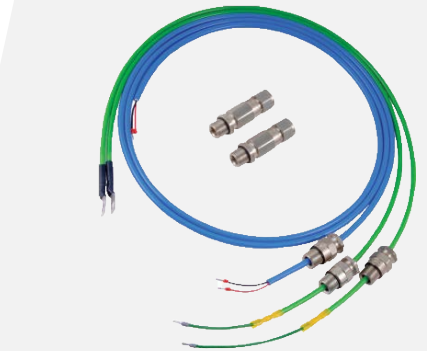

Kit A - with Ex d glands, for use with armoured cable

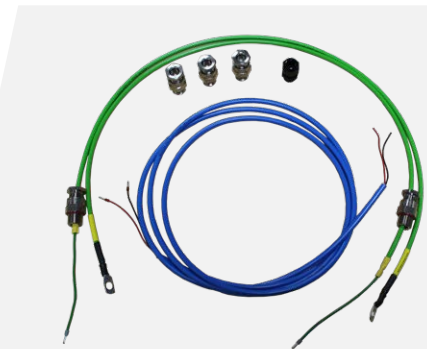

Kit B - with Ex d glands, for use with non-armoured cable



Kit C - with Ex e glands, for use with non-armoured cable

## System Options

### Intrinsically Safe (I.S) Switching PCB

The I.S Switching PCB is an additional circuit board added to Newson Gale system enclosures to enable users to directly interface with, and switch intrinsically safe circuits without the need for additional equipment. The I.S Switching PCB is designed not to affect the I.S signals electrical parameters and is compatible with the Earth-Rite II FIBC platforms.

- 30 V DC, 500 mA
- $L_i = 0H$ ,  $C_i = 0F$
- Suitable for Ex ia, ib, ic rated intrinsically safe circuits only
- NAMUR Compatible



### Universal Resistance Tester (URT)

The URT is designed to provide users of Newson Gale **Earth-Rite®** static grounding systems with a means of testing the permissive resistance range on a regular basis.

The easy to use tester consists of a pair of rotary switches that enable a competent electrical person to check the resistance level at which the grounding system should be working and conduct a PASS / FAIL test at the required setting.



#### Copyright Notice

The website and its content is copyright of Newson Gale Ltd © 2020. All rights reserved.

Any redistribution or reproduction of part or all of the contents in any form is prohibited other than the following:

- you may print or download to a local hard disk extracts for your personal and noncommercial use only
- you may copy the content to individual third parties for their personal use, but only if you acknowledge the website as the source of the material

You may not, except with our express written permission, distribute or commercially exploit the content. Nor may you transmit it or store it in any other website or other form of electronic retrieval system.

#### Right to change

This document provides general information only and may be subject to change at any time without notice. All information, representations, links or other messages may be changed by Newson Gale at any time without prior notice or explanation.

Newson Gale is not obliged to remove any outdated information from its content or to expressly mark it as being outdated. Please seek the advice of professionals as necessary regarding the evaluation of any content.

#### Disclaimer of liability

The information provided in this Datasheet is provided by Newson Gale without any representations or warranties, expressed or implied, as to its accuracy or completeness. The liability of Newson Gale for any expenses, losses or actions incurred whatsoever by the recipient as a result of the use of this Datasheet shall be excluded.

Leading the way in hazardous area static control



www.newson-gale.com

8/8

United Kingdom  
**Newson Gale Ltd**  
 Omega House  
 Private Road 8  
 Colwick, Nottingham  
 NG4 2JX, UK  
 +44 (0)115 940 7500  
 groundit@newson-gale.co.uk

United States  
**IEP Technologies LLC**  
 417-1 South Street  
 Marlborough, MA 01752  
 USA  
 +1 732 961 7610  
 groundit@newson-gale.com

Deutschland  
**IEP Technologies GmbH**  
 Kaiserswerther Str. 85C  
 40878 Ratingen  
 Germany  
 +49 (0)2102 58890  
 erdung@newson-gale.de