

Earth-Rite® DGS

Dual Grounding System



Online Inquiry >



Earth-Rite® DGS Grounding System



Protecting plant and personnel from the hazards associated with electrostatic discharge is usually the responsibility of HAZMAT professionals and engineers. Effective grounding and bonding procedures are always the first step in controlling static with special solutions being called for to suit individual applications.

There are times when one or two plant items need to be grounded simultaneously and both of their grounding connections monitored to less than 10 Ohms as required by International Standards Guidance and / or Recommended Practices. The Earth-Rite DGS is the ideal solution for grounding up to two bulk transportation vehicles or other objects to be grounded simultaneously.

The Earth-Rite DGS includes:

- **XP Ex (d) aluminium enclosure** (suitable for installation in Class 1, Div 1, A to G) with dual Intrinsically Safe Continuous Ground Monitoring Circuits (Ex [ia] suitable for use in Class 1, Div 1, A to G)
- **A very simple "GO / NO GO" user interface** for each grounding channel. A single RED LED indicates to the operator a "NO GO" situation. Three flashing high intensity GREEN LEDs per channel indicates to the operator when the ground monitoring circuits have detected a resistance of 10 Ohms or less
- **2 Ground Connection Junction Boxes** are provided and are complete with a stowage pin, VESX90-IP grounding clamp and a 2 conductor Cen-Stat protected spiral cable and quick connectors (10', 16', 32', 48' or 96' lengths are available)

Interlocking the grounding system with the process equipment being used enhances the safety and operating procedure before the process starts. If the ground is lost then the Earth-Rite DGS can shut down the process for one or both of the channels. Interlocking the grounding system with strobes provides personnel working in the surrounding area with a clear view of when the grounded process is underway and protected.

Typical Applications

- Two metal drums
- Two Ex IBCs
- Two rail cars
- Transloading (railcar to truck or truck to rail car)
- LACT (Lease Automatic Custody Transfer) skids

Or any combination of the plant items above.

* Always check for and read the latest version of the following **International Standards, Guidance** and / or **Recommended Practices** for more useful information on static hazards and solutions:

IEC TS 60079-32-1 Explosive atmospheres. Electrostatic hazards, guidance

NFPA 77 "Recommended Practice on Static Electricity"

API RP 2003 Protection Against Ignitions Arising out of Static, Lightning, and Stray Currents.

Technical Specification

XP (Class I, II, III - Div 1 Installations)

Monitoring Unit

Power Supply	90 V to 265 V AC, 50-60 Hz
Power Rating	10 watts
Ambient Temperature Range	-40°F to +122°F (- 40°C to + 50°C)
Ingress Protection	IP 66
Weight	15.43 lbs (7 kgs) (nett)
Construction	Copper-free cast aluminium
Monitoring Circuit	Intrinsically safe
Monitoring Loop Resistance	Nominally ≤ 10 ohm per channel (+/- 10%)
Output Relay Contact Rating	3 off dry contacts, 250 V AC, 5 A, 500 VA max resistive 30 V DC, 2 A, 60 W max resistive
Cable Entries	4 x 3/4" NPT 2 in the West Face (EX) 2 in the South Face (NonEX)

2 Junction Boxes complete with Stowage Point

Enclosure Material	GRP with carbon loading
Terminals	2 x 2.5 mm ² conductor capacity
Stowage Device	Insulated universal stowage pin
Cable Entries	1 x M20 x 1.5
Clamp Cable Connection	Quick Connect

Grounding Clamp

Clamp Design	2 pole with tungsten carbide teeth
Body	Stainless steel (SS grade: 304)

ATEX / FM / IECEx / UKEX Certification:

ATEX
 II 1 GD T6
 (Assessed to EN 13463-1 : 2009)
 Sira 02ATEX9381
 ATEX Notified Body: SIRA
FM Certificate of Compliance number: 3046346

UKCA Ex

 II 1 G
 II 1 D
 Ex h IIC T6 Ga
 Ex h IIIC T85°C Da
 Ta = -40°C to +60°C
 ExVeritas 21UKEX0842
 UKCA Ex Approved Body: ExVeritas

IECEx
 Ex h IIC T6 Ga
 Ex h IIIC T85°C Da
 Ta = -40°C to +60°C
 IECEx EXV 20.0033
 IECEx Certified Body: ExVeritas

Spiral Cable

Cable	Blue Cen-Stat Hytrel sheath (Static dissipative, chemical & abrasion resistant)
Conductors	2 x AWG #16 copper
Length	3 m (10 ft), 5 m (16 ft), 10 m (32 ft) or 15 m (50 ft) 2 pole Cen-Stat blue spiral cable with Hytrel coating which has colour, UV protective and static dissipative additives

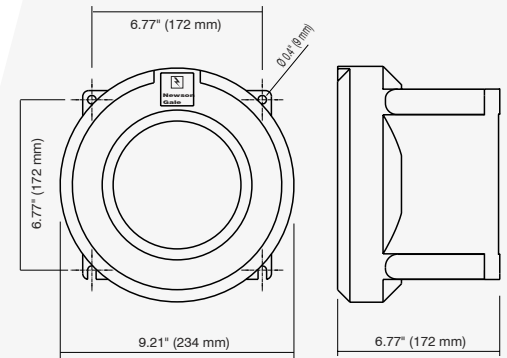

Copper free cast aluminium enclosure - IP 66

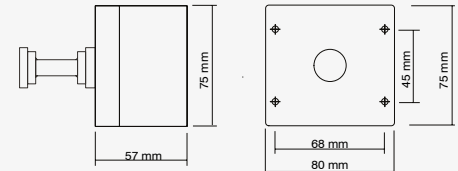

Simple Apparatus
GRP junction box with nylon grounding clamp stowage pin

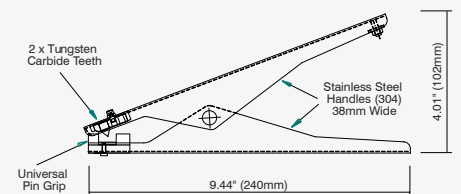

Dual core stainless steel grounding clamp fitted with one pair of tungsten carbide tips

Earth-Rite® DGS

Hazardous Location Approvals

North America:

Europe / International Version Available:

NEC 500 / CEC (Class & Division)

Class I, Div. 1, Groups A, B, C and D, T6
 Class II, Div. 1, Groups E, F, G, T135°C
 Class III, Div. 1, 135°C
 Associated Equipment for
 Class I, Div. 1, Groups A, B, C & D
 Class II, Div. 1, Groups E, F, G
 Class III, Division 1
 Ex db [ia Ga] IIC T6 Gb
 Ex tb [ia Da] IIIC T135°C Db
 Ambient Temperature Range
 -40°C ≤ Tamb ≤ +50°C
 Ambient Temperature Range
 -40°F ≤ Tamb ≤ +122°F
 Enclosure type: 4X, IP66
 OSHA recognised NRTL: CSA Group

IECEX

Ex db [ia Ga] IIC T6 Gb
 Ex tb [ia Da] IIIC T135°C Db
 Ta = -40°C to +50°C
 IECEX EXV 19.0069
 IECEX Certifying Body: ExVeritas

ATEX

 II 2(1)G
 II 2(1)D
 Ex db [ia Ga] IIC T6 Gb
 Ex tb [ia Da] IIIC T135°C Db
 Ta = -40°C to +50°C
 ExVeritas 19ATEX0564
 ATEX Notified Body: ExVeritas

UKCA Ex

 II 2(1)G
 II 2(1)D
 Ex db [ia Ga] IIC T6 Gb
 Ex tb [ia Da] IIIC T135°C Db
 Ta = -40°C to +50°C
 ExVeritas 21UKEX0841
 UKCA Ex Approved Body: ExVeritas

NEC 505 & 506 (Class & Zoning)

Class I, Div. 1, Groups A, B, C and D T6
 Class II, Div. 1, Groups E, F, G T135°C
 Class III, Division 1 T135°C
 Associated Equipment for
 Class I, Division 1, Groups A, B, C and D
 Class II, Division 1, Groups E, F, G
 Class III, Division 1
 Class I, Zone 1, AEx db [ia Ga] IIC T6 Gb
 Zone 21, AEx tb [ia Da] IIIC T135°C Db
 Ambient Temperature Range
 -40°C ≤ Tamb ≤ +50°C
 Ambient Temperature Range
 -40°F ≤ Tamb ≤ +122°F
 Enclosure type: 4X, IP66

KCS (Gas)

Ex db [ia Ga] IIC T6 Gb
 Ta = -40°C to +50°C
 22-AV4BO-0348X
 Approved Body: KOSHA

KCS (Dust)

Ex tb [ia Da] IIIC T135°C IP66 Db
 Ta = -40°C to +50°C
 22-AV4BO-0349X
 Approved Body: KOSHA

Additional Certification

EMC Tested:

to EN 61000-6-3, EN 61000-6-2
 FCC - Part 15 (Class A)

System Options

Retractable Cable Reel

The Retractable Cable Reel is supplied for grounding system installations where customers want to ensure the grounding clamp and cable are returned to the static grounding system by operators and drivers on completion of the product transfer process. The reel can be used in conjunction with the **Earth-Rite® DGS**.

- Certified for ATEX Zone 1 and 21 hazardous areas
- Self-retracting with up to 15 m (50 ft.) of Hytrel® protected cable
- Silver plated ultra low resistance slip ring contacts
- ATEX - Ex II 2 GD T6



Hazardous Area Strobe Light

The strobe light is mounted in an elevated position and when the equipment is correctly grounded, flashes continuously informing personnel that a transfer process is underway and is protected from the static hazard. The strobe light can be used in conjunction with the **Earth-Rite DGS**.

- ATEX and Class/Div approved versions.
- 115 V / 230 V AC and 24 V / 48 V DC options.
- Amber, Green & Red strobe colour options.



Universal Resistance Tester

The URT is designed to provide owners of Newson Gale Earth-Rite® static grounding systems with a means of regularly testing the permissive resistance range on a regular basis.

The easy to use tester consists of a pair of switches that enable an electrician to set up the resistance level at which the grounding system should be working and conduct a PASS / FAIL test at the required setting.



Copyright Notice

The website and its content is copyright of Newson Gale Ltd © 2021. All rights reserved.

Any redistribution or reproduction of part or all of the contents in any form is prohibited other than the following:

- you may print or download to a local hard disk extracts for your personal and noncommercial use only
- you may copy the content to individual third parties for their personal use, but only if you acknowledge the website as the source of the material

You may not, except with our express written permission, distribute or commercially exploit the content. Nor may you transmit it or store it in any other website or other form of electronic retrieval system.

Right to change

This document provides general information only and may be subject to change at any time without notice. All information, representations, links or other messages may be changed by Newson Gale at any time without prior notice or explanation.

Newson Gale is not obliged to remove any outdated information from its content or to expressly mark it as being outdated. Please seek the advice of professionals as necessary regarding the evaluation of any content.

Disclaimer of liability

The information provided in this Datasheet is provided by Newson Gale without any representations or warranties, expressed or implied, as to its accuracy or completeness. The liability of Newson Gale for any expenses, losses or actions incurred whatsoever by the recipient as a result of the use of this Datasheet shall be excluded.

Leading the way in hazardous area static control



www.newson-gale.com

5/5

United Kingdom
Newson Gale Ltd
Omega House
Private Road 8
Colwick, Nottingham
NG4 2JX, UK
+44 (0)115 940 7500
groundit@newson-gale.co.uk

United States
IEP Technologies LLC
417-1 South Street
Marlborough, MA 01752
USA
+1 732 961 7610
groundit@newson-gale.com

Deutschland
IEP Technologies GmbH
Kaiserswerther Str. 85C
40878 Ratingen
Germany
+49 (0)2102 58890
erdung@newson-gale.de